

Typ	M-SVP 32/21-6/E	Bestell-Nr.	MZ 69614	FI	LSS	Steckdosen
Anschlussleistung 22 kVA Einspeisung: 1 CEE-Gerätestecker 32A 5p 400V				1 FI 40/0,03A	2 LSS 16A 3p-C 3 LSS 16A 1p-C	2 CEE-Dosen 16A 5p 400V 1 CEE-Dose 32A 5p 400V 6 Schutzk.SD 16A 250V Kabelschleife (nicht über FI) 1 CEE-Dose 32A 5p 400V

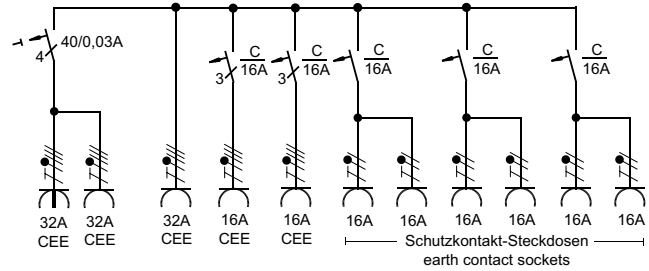

Typ	M-SVP 63/111-6	Bestell-Nr.	MZ 69630	FI	LSS	Steckdosen
Anschlussleistung 44 kVA Einspeisung: 1 CEE-Gerätestecker 63A 5p 400V				1 FI 63/0,03A	1 LSS 16A 3p-C 1 LSS 32A 3p-C 3 LSS 16A 1p-C	1 CEE-Dose 16A 5p 400V 1 CEE-Dose 32A 5p 400V 1 CEE-Dose 63A 5p 400V 6 Schutzk.SD 16A 250V

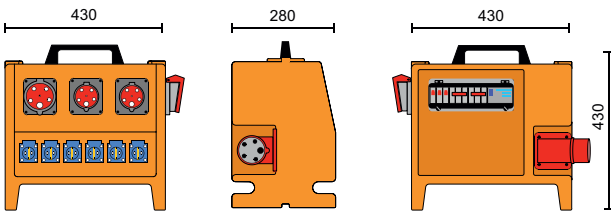
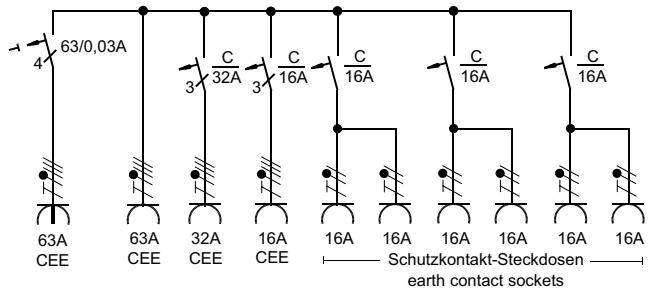
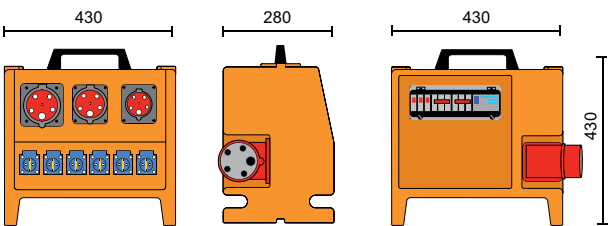

Typ	M-SVP 63/021-6	Bestell-Nr.	MZ 69631	FI	LSS	Steckdosen
Anschlussleistung 44 kVA Einspeisung: 1 CEE-Gerätestecker 63A 5p 400V				1 FI 63/0,03A	2 LSS 32A 3p-C 3 LSS 16A 1p-C	2 CEE-Dosen 32A 5p 400V 1 CEE-Dose 63A 5p 400V 6 Schutzk.SD 16A 250V

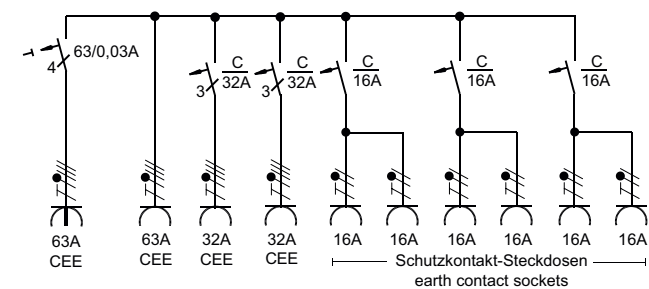
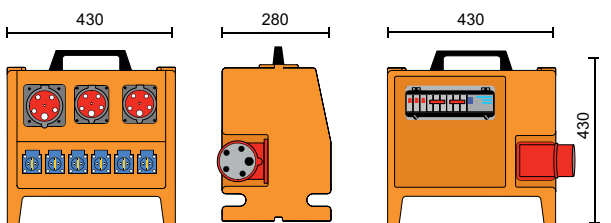

Typ	M-SVP TG	Bestell-Nr.	MZ 69609	Beschreibung
-----	----------	-------------	----------	--------------

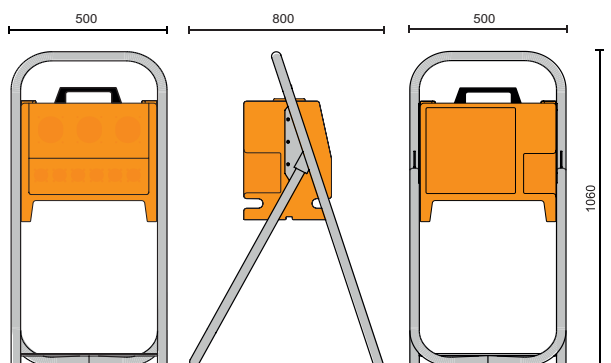

Alle Steckdosenverteiler der Serie M-SVP sind optional auch mit einem geschweißten und verzinkten Untergestell ausrüstbar. (Lieferung ohne Verteiler.)